

# ATLAS

## Series A & L Rod Gland Kits

### Series A & L Cylinders Nitrile

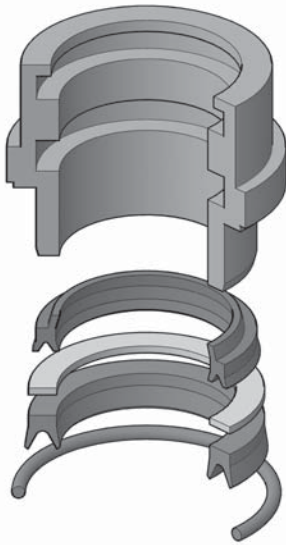

**Kit Includes:**  
 1 Bronze Gland  
 1 XNBR Wiper  
 1 PTFE Back-Up Ring  
 1 NBR U-Seal  
 1 NBR O-Ring

### Series L Cylinders Urethane

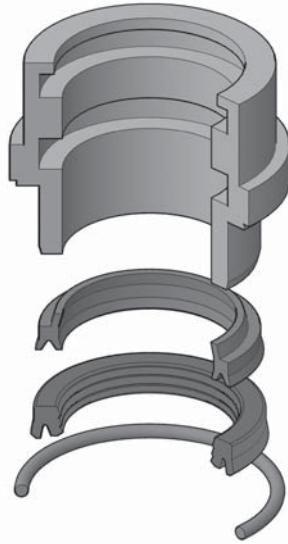

**Kit Includes:**  
 1 Bronze Gland  
 1 XNBR Wiper  
 1 Multi-lip Urethane U-Seal  
 1 NBR O-Ring

### Series A & L Cylinders Fluorocarbon

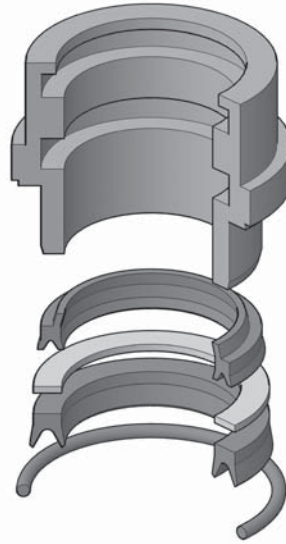

**Kit Includes:**  
 1 Bronze Gland  
 1 FC Wiper  
 1 PTFE Back-Up Ring  
 1 FC U-Seal  
 1 FC O-Ring

### Series A & L Cylinders Bronze

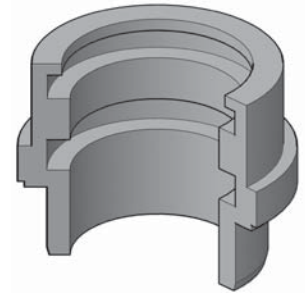

**Kit Includes:**  
 1 Bronze Gland

Rod Dia.	(NBR) Kit #	List Price	(URE) Kit #	List Price	(FC) Kit #	List Price	(BZ) Kit #	List Price
5/8"	ATL-4A06R000S	\$ 85.70	ATL-EA06R000S	\$ 89.27	ATL-4A06R000V	\$ 113.80	ATL-RGAL-06	\$ 76.60
1"	ATL-4A10R000S	100.85	ATL-EA10R000S	99.84	ATL-4A10R000V	133.73	ATL-RGAL-10	86.03
1-3/8"	ATL-4A13R000S	120.80	ATL-EA13R000S	114.75	ATL-4A13R000V	138.02	ATL-RGAL-13	100.85
1-3/4"	ATL-4A17R000S	142.42	ATL-EA17R000S	135.50	ATL-4A17R000V	164.15	ATL-RGAL-17	117.76
2"	ATL-4A20R000S	167.08	ATL-EA20R000S	166.26	ATL-4A20R000V	192.12	ATL-RGAL-20	142.85
2-1/2"	ATL-4A25R000S	190.05	ATL-EA25R000S	186.84	ATL-4A25R000V	228.62	ATL-RGAL-25	161.29
3"	ATL-4A30R000S	234.73	ATL-EA30R000S	248.82	ATL-4A30R000V	276.80	ATL-RGAL-30	200.72

# ATLAS

## Series 2LA Rod Gland Kits

### Series 2LA Air Cylinders

**Nitrile**

**Fluorocarbon**

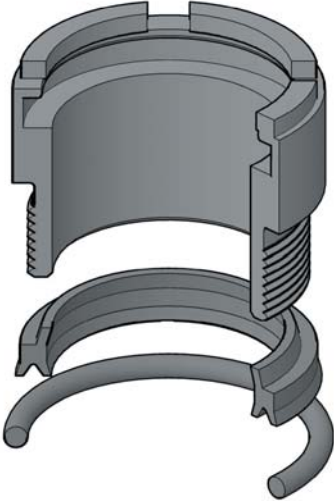
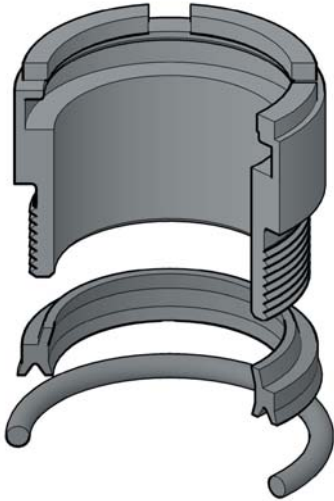

**1/2" - 1-3/4"**

**Kit Includes:**

- 1 Bronze gland
- 1 XNBR Wiper/Seal
- 1 NBR O-Ring
- 1 Tube Seal Lubricant

**1/2" - 1-3/4"**

**Kit Includes:**

- 1 Bronze gland
- 1 FC Wiper/Seal
- 1 FC O-Ring
- 1 Tube Seal Lubricant

Bore Dia.	(NBR) Kit #	List Price	(FC) Kit #	List Price
1/2"	ATL-RG02MA0051	\$ 39.34	ATL-RG02MA0055	\$ 41.92
5/8"	ATL-RG02MA0061	25.99	ATL-RG02MA0065	41.51
1"	ATL-RG02MA0101	29.78	ATL-RG02MA0105	45.99
1-3/8"	ATL-RG02MA0131	44.47	ATL-RG02MA0135	66.48
1-3/4"	ATL-RG02MA0171	90.50	ATL-RG02MA0175	101.52

ATLAS

# ATLAS

## Series A & L Rod Seal Kits

### Series A Cylinders Nitrile



**Kit Includes:**

- 1 XNBR Wiper
- 1 PTFE Back-up Ring
- 1 NBR U-Seal
- 1 NBR O-Ring

### Series L Cylinders Urethane



**Kit Includes:**

- 1 XNBR Wiper
- 1 Multi-lip Urethane U-Seal
- 1 NBR O-Ring

### Series A & L Cylinders Fluorocarbon



**Kit Includes:**

- 1 FC Wiper
- 1 PTFE Back-up Ring
- 1 FC U-Seal
- 1 FC O-Ring

Rod Dia.	(NBR) Kit #	List Price	(URE) Kit #	List Price	(FC) Kit #	List Price
5/8"	ATL-4A06S000S	\$ 9.77	ATL-EA06S000S	\$ 8.23	ATL-4A06S000V	\$ 27.13
3/4"	ATL-4A07S000S	13.16	—		ATL-4A07S000V	38.93
1"	ATL-4A10S000S	9.78	ATL-EA10S000S	8.86	ATL-4A10S000V	27.97
1-3/8"	ATL-4A13S000S	10.03	ATL-EA13S000S	9.45	ATL-4A13S000V	29.42
1-3/4"	ATL-4A17S000S	12.63	ATL-EA17S000S	11.05	ATL-4A17S000V	32.98
2"	ATL-4A20S000S	14.11	ATL-EA20S000S	14.25	ATL-4A20S000V	34.34
2-1/2"	ATL-4A25S000S	19.21	ATL-EA25S000S	16.29	ATL-4A25S000V	43.42
3"	ATL-4A30S000S	27.43	ATL-EA30S000S	33.02	ATL-4A30S000V	50.99
3-1/2"	ATL-4A35S000S	30.01	ATL-EA35S000S	47.81	ATL-4A35S000V	63.40
4"	ATL-4A40S000S	32.21	ATL-EA40S000S	53.28	ATL-4A40S000V	97.03
4-1/2"	ATL-4A45S000S	39.34	ATL-EA45S000S	59.25	ATL-4A45S000V	109.42
5"	ATL-4A50S000S	45.86	ATL-EA50S000S	64.27	ATL-4A50S000V	147.17

# ATLAS

## Series 2LA Rod Kits

### Series 2LA Air Cylinders

Nitrile

Fluorocarbon

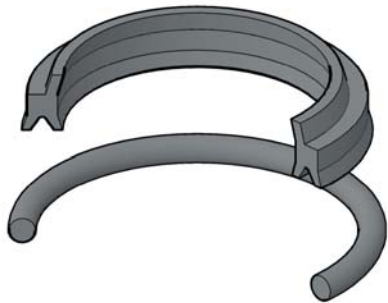
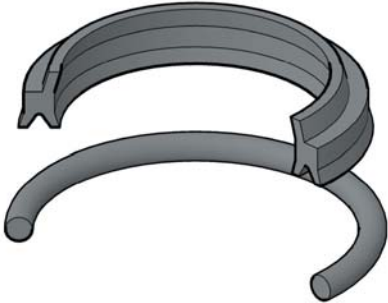

**1/2" - 1-3/4"**

**Kit Includes:**

- 1 XNBR Wiper/Seal
- 1 NBR O-Ring
- 1 Tube Seal Lubricant

**1/2" - 1-3/4"**

**Kit Includes:**

- 1 FC Wiper/Seal
- 1 FC O-Ring
- 1 Tube Seal Lubricant

Rod Dia.	(NBR) Kit #	List Price	(FC) Kit #	List Price
1/2"	ATL-RK02MA0051	\$ 12.70	ATL-RK02MA0055	\$ 18.98
5/8"	ATL-RK02MA0061	13.09	ATL-RK02MA0065	19.50
1"	ATL-RK02MA0101	13.42	ATL-RK02MA0105	20.14
1-3/8"	ATL-RK02MA0131	14.36	ATL-RK02MA0135	25.22
1-3/4"	ATL-RK02MA0171	15.34	ATL-RK02MA0175	31.71

ATLAS

# ATLAS

## Series A & L Piston Kits

### Series A Cylinders Nitrile

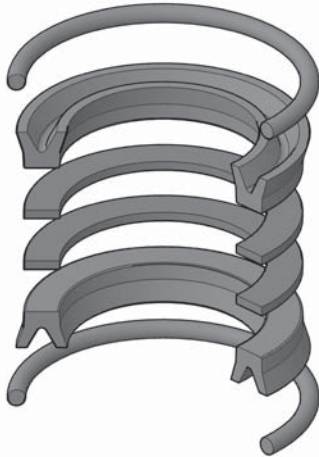

**Kit Includes:**

- 2 NBR U-Seals
- 2 HP URE Back-Up Rings
- 2 NBR O-Ring Head Seals

### Series L Cylinders Nitrile

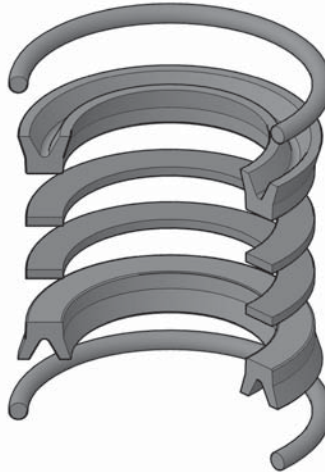

**Kit Includes:**

- 2 NBR U-Seals
- 2 HP URE Back-Up Rings
- 2 NBR O-Ring Head Seals

### Series A & L Cylinders Fluorocarbon



**Kit Includes:**

- 2 FC U-Seals
- 2 HP URE Back-Up Rings
- 2 FC O-Ring head Seals

Bore Dia.	(NBR) Kit #	List Price	(NBR) Kit #	List Price	(FC) Kit #	List Price
1-1/2"	ATL-4B00S015S	\$ 7.87	ATL-EB00S015S	\$ 7.87	ATL-4B00S015V	\$ 36.15
2"	ATL-4B00S020S	9.38	ATL-EB00S020S	9.38	ATL-4B00S020V	41.33
2-1/2"	ATL-4B00S025S	10.74	ATL-EB00S025S	10.74	ATL-4B00S025V	57.27
3-1/4"	ATL-4B00S032S	13.04	ATL-EB00S032S	13.04	ATL-4B00S032V	61.49
4"	ATL-4B00S040S	16.62	ATL-EB00S040S	16.62	ATL-4B00S040V	72.92
5"	ATL-4B00S050S	20.12	ATL-EB00S050S	20.12	ATL-4B00S050V	90.44
6"	ATL-4B00S060S	26.14	ATL-EB00S060S	26.14	ATL-4B00S060V	124.38
7"	ATL-4B00S070S	72.88	ATL-4B00S070S	72.88	ATL-4B00S070V	224.89
8"	ATL-4B00S080S	82.68	ATL-EB00S080S	82.68	ATL-4B00S080V	271.13
10"	ATL-4B00S100S	117.69	ATL-4B00S100S	117.69	ATL-4B00S100V	375.74
12"	ATL-4B00S120S	159.28	ATL-4B00S120S	159.28	ATL-4B00S120V	583.20
14"	ATL-4B00S140S	246.61	ATL-4B00S140S	246.61	ATL-4B00S140V	859.73

HP URE - High Performance Urethane

# ATLAS

## Series 2LA Piston Kits

### Series 2LA Air Cylinders

Nitrile

Fluorocarbon

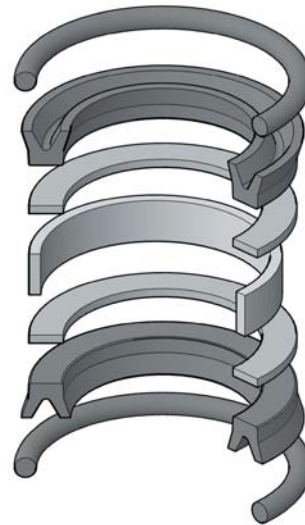
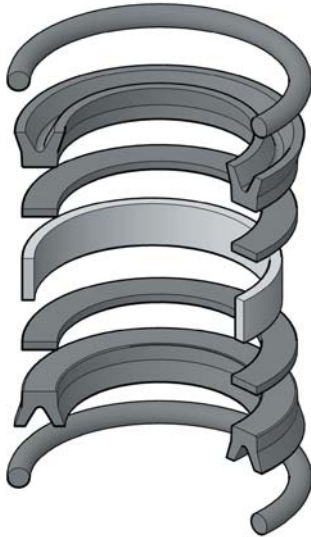

**Kit Includes:**

- 2 NBR O-ring Head Seals
- 2 NBR U-Seals
- 2 URE Back-up Rings
- 1 Nylon Wear Ring
- 1 Tube Seal Lubricant

**Kit Includes:**

- 2 FC O-ring Head Seals
- 2 FC U-Seals
- 2 PTFE Back-up Rings
- 1 Nylon Wear Ring
- 1 Tube Seal Lubricant

Bore Dia.	(NBR) Kit #	List Price	(FC) Kit #	List Price
1-1/2"	ATL-PK1502MA01	\$ 23.67	ATL-PK1502MA05	\$ 46.12
2"	ATL-PK2002MA01	23.99	ATL-PK2002MA05	49.38
2-1/2"	ATL-PK2502MA01	25.72	ATL-PK2502MA05	65.55
3-1/4"	ATL-PK3202MA01	30.92	ATL-PK3202MA05	81.02
4"	ATL-PK4002MA01	37.91	ATL-PK4002MA05	91.79
5"	ATL-PK5002MA01	49.06	ATL-PK5002MA05	138.91
6"	ATL-PK6002MA01	65.59	ATL-PK6002MA05	196.74
8"	ATL-PK8002MA01	115.80	ATL-PK8002MA05	328.99

ATLAS

# ATLAS

## Series A & L Head Seal Kits

### Series A & L Head Seal Kits

Nitrile

Fluorocarbon

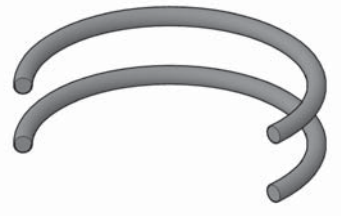

**Kit Includes:**  
2 NBR O-Ring Head Seals

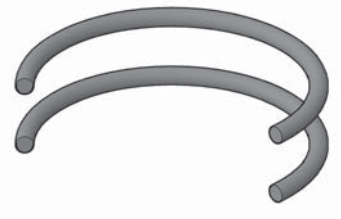

**Kit Includes:**  
2 FC O-Ring Head Seals

Bore Dia.	(NBR) Kit #	List Price	(FC) Kit #	List Price
1-1/2"	ATL-4E00S015S	\$ 4.56	ATL-4E00S015V	\$ 6.56
2"	ATL-4E00S020S	4.84	ATL-4E00S020V	11.15
2-1/2"	ATL-4E00S025S	5.41	ATL-4E00S025V	14.61
3-1/4"	ATL-4E00S032S	5.48	ATL-4E00S032V	17.06
4"	ATL-4E00S040S	5.75	ATL-4E00S040V	21.97
5"	ATL-4E00S050S	6.72	ATL-4E00S050V	30.92
6"	ATL-4E00S060S	8.32	ATL-4E00S060V	32.62
7"	ATL-4E00S070S	8.43	ATL-4E00S070V	46.10
8"	ATL-4E00S080S	10.27	ATL-4E00S080V	46.24
10"	ATL-4E00S100S	11.91	ATL-4E00S100V	51.50
12"	ATL-4E00S120S	13.74	ATL-4E00S120V	62.10
14"	ATL-4E00S140S	69.52	ATL-4E00S140V	124.67

ATLAS

# ATLAS

## Series H Rod Seal Kits

### Nitrile

### Series H Rod Seal Kits

### Fluorocarbon



**Kit Includes:**

- 1 URE Wiper (For cyl. mfg. before April 2005)
- 1 XNBR Wiper (For cyl. mfg. April 2005 and after)
- 1 Multi-lip URE U-Seal
- 1 NBR O-Ring

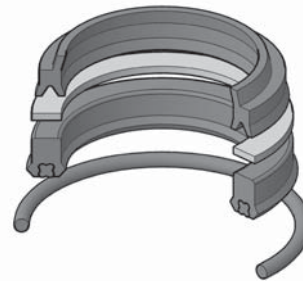

**Kit Includes:**

- 1 FC Wiper (For cyl. mfg. April 2005 and after\*)
- 1 PTFE Back-Up Rings
- 1 FC Loaded FC U-Seals
- 1 FC O-Ring

Rod Dia.	(NBR) Kit #	List Price	(FC) Kit #	List Price
5/8"	ATL-PH06SH000	\$ 8.84	ATL-VH06SH000	\$ 27.00
1"	ATL-PH10SH000	9.55	ATL-VH10SH000	38.11
1-3/8"	ATL-PH13SH000	12.83	ATL-VH13SH000	39.75
1-3/4"	ATL-PH17SH000	12.95	ATL-VH17SH000	47.13
2"	ATL-PH20SH000	17.71	ATL-VH20SH000	53.97
2-1/2"	ATL-PH25SH000	22.09	ATL-VH25SH000	87.24
3"	ATL-PH30SH000	23.44	ATL-VH30SH000	100.52
3-1/2"	ATL-PH35SH000	45.35	ATL-VH35SH000	139.74

\* Fluorocarbon Rod Seal Kits for cylinders manufactured before April 2005 use a bronze AN style wiper ring.



# ATLAS

## Series H (for cylinders manufactured before April 2005) Piston Seal Kits

ATLAS

### Series H Piston Seal Kits

Nitrile

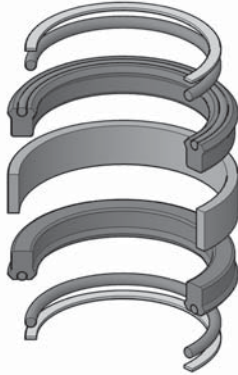

**Kit Includes:**

- \* See notes below
- 2 NBR Loaded URE U-Seals
- 1 Nylon Wear Ring
- 2 NBR O-Ring Head Seals
- 2 PTFE Back-up Rings

Fluorocarbon

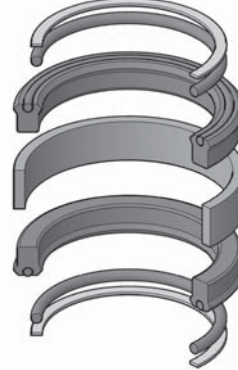

**Kit Includes:**

- \* See notes below
- 2 FC Loaded FC U-Seals
- 1 Nylon Wear Ring
- 2 FC O-Ring Head Seals
- 2 PTFE Back-Up Rings

Bore Dia.	(NBR) Kit #	List Price	(FC) Kit #	List Price
1-1/2"	ATL-1B00S015S	\$ 16.38	ATL-1B00S015V	\$ 49.62
2"	ATL-1B00S020S	19.08	ATL-1B00S020V	55.23
2-1/2"	ATL-1B00S025S	20.37	ATL-1B00S025V	58.62
3-1/4"	ATL-1B00S032S	31.37	ATL-1B00S032V	83.74
4"	ATL-1B00S040S	40.24	ATL-1B00S040V	120.68
5"	ATL-1B00S050S	84.56	ATL-1B00S050V	181.70
6"	ATL-1B00S060S	144.89	ATL-1B00S060V	246.63
7"	ATL-1B00S070S	189.31	ATL-1B00S070V	378.76
8"	ATL-1B00S080S	200.94	ATL-1B00S080V	397.69
10"	ATL-1B00S100S	262.68	ATL-1B00S100V	527.04
12"	ATL-1B00S120S	333.79	ATL-1B00S120V	647.21

\* Kit contents are size dependant:  
 1-1/2" thru 4" - U-Seals and O-Rings  
 5" - U-Seals, O-Rings and Wear Rings  
 6" - Same as 5, also includes 2 PTFE U-Seal Back-Up Rings  
 7" thru 12" - contain all parts listed

(for cylinders manufactured April 2005 and after) **Series H**  
 (1-1/2" to 6" Bores) **Piston Seal Kits**

**Series H Piston Seal Kits**

**Nitrile**



**Kit Includes:**  
 2 NBR O-Ring Head Seals  
 2 HP URE Back-up Rings  
 2 NBR U-Seals

**Fluorocarbon**



**Kit Includes:**  
 2 FC O-Ring Head Seals  
 2 PTFE Back-Up Rings  
 2 FC U-Seals

Bore Dia.	(NBR) Kit #	List Price	(FC) Kit #	List Price
1-1/2"	ATL-PH00LH015	\$ 12.64	ATL-VH00LH015	\$ 44.46
2"	ATL-PH00LH020	13.36	ATL-VH00LH020	64.06
2-1/2"	ATL-PH00LH025	15.88	ATL-VH00LH025	73.77
3-1/4"	ATL-PH00LH032	29.05	ATL-VH00LH032	85.21
4"	ATL-PH00LH040	34.56	ATL-VH00LH040	194.85
5"	ATL-PH00LH050	50.78	ATL-VH00LH050	292.73
6"	ATL-PH00LH060	75.99	ATL-VH00LH060	344.18

HP URE - High Performance Urethane

# ATLAS

## Series H (for cylinders manufactured April 2005 and after) Piston Seal Kits (7" & 8" Bores)

ATLAS

### Series H Piston Seal Kits

**Nitrile**



**Kit Includes:**

- 2 NBR Back-Up Rings
- 2 NBR O-Ring Head Seals
- 2 Nylon Wear Rings
- 1 Bronze filled PTFE Piston Ring  
w/ 1 NBR Expander

**Fluorocarbon**



**Kit Includes:**

- 2 PTFE Back-Up Rings
- 2 FC O-Ring Head Seals
- 2 Nylon Wear Rings
- 1 Bronze filled PTFE Piston Ring  
w/1 FC Expander

Bore Dia.	(NBR) Kit #	List Price	(FC) Kit #	List Price
7"	ATL-PH00KH070	\$ 306.07	ATL-VH00KH070	\$ 309.60
8"	ATL-PH00KH080	372.01	ATL-VH00KH080	382.00

High load Piston Seal Kits are standard for 7" & 8" Bores

# ATLAS

(for cylinders manufactured before April 2005) **Series H  
Head Seal Kits**

## Series H Head Seal Kits

**Nitrile**

**Fluorocarbon**



**Kit Includes:**  
2 NBR O-Ring Head Seals  
2 PTFE Back-up Rings\*



**Kit Includes:**  
2 FC O-Ring Head Seals  
2 PTFE Back-up Rings\*

Bore Dia.	(NBR) Kit #	List Price	(FC) Kit #	List Price
1-1/2"	ATL-1E00S015S	\$ 3.99	ATL-1E00S015V	\$ 5.93
2"	ATL-1E00S020S	5.12	ATL-1E00S020V	7.06
2-1/2"	ATL-1E00S025S	6.85	ATL-1E00S025V	8.47
3-1/4"	ATL-1E00S032S	12.80	ATL-1E00S032V	16.74
4"	ATL-1E00S040S	15.48	ATL-1E00S040V	18.11
5"	ATL-1E00S050S	18.56	ATL-1E00S050V	28.17
6"	ATL-1E00S060S	29.13	ATL-1E00S060V	30.42
7"	ATL-1E00S070S	61.70	ATL-1E00S070V	71.73
8"	ATL-1E00S080S	65.62	ATL-1E00S080V	83.71
10"	ATL-1E00S100S	119.32	ATL-1E00S100V	134.39
12"	ATL-1E00S120S	135.61	ATL-1E00S120V	154.71

\* Back-up Rings in 7", 8", 10" and 12" kits only

ATLAS

## ATLAS

# Bronze Rod Glands

### Series 2LA Air Cylinders

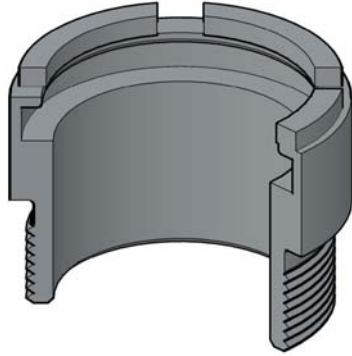

Rod Dia.	Kit #	List Price
1/2"	ATL-RG02MA-05	\$ 35.43
5/8"	ATL-RG02MA-06	26.11
1"	ATL-RG02MA-10	32.68
1-3/8"	ATL-RG02MA-13	47.25
1-3/4"	ATL-RG02MA-17	77.01

# ATLAS

## Rod Kits

### Hydraulic Cylinders

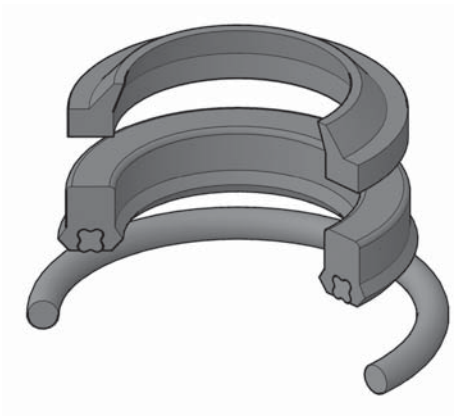

**Kit Includes:**  
 1 URE Wiper  
 1 URE Loaded U-seal  
 1 NBR O-ring

Rod Dia.	Kit #	List Price
5/8"	ATL-HRK62	\$ 8.47
1"	ATL-HRK100	10.15
1-3/8"	ATL-HRK137	11.78
1-3/8"	ATL-90030340-79	13.74
1-3/8"	ATL-90030370-79	11.27
1-3/4"	ATL-HRK175	13.01
1-3/4"	ATL-90030340-69	12.29
1-3/4"	ATL-90030370-69	12.18
2"	ATL-HRK200	13.95

## Piston Kits

### Pneumatic Cylinders

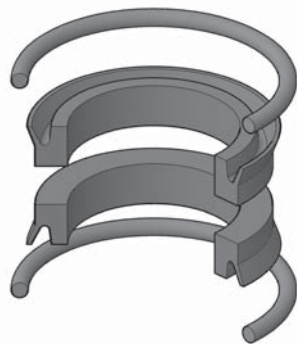

**Kit Includes:**  
 2 URE U-seals  
 2 NBR O-rings

Bore Dia.	Kit #	List Price
1-1/2"	—	
2"	ATL-APK20-000	\$ 12.82
2-1/2"	ATL-APK25-000	13.55
3-1/4"	—	
4"	ATL-APK40-000	37.28
5"	ATL-APK50-000	37.58
6"	ATL-APK60-000	44.30
8"	ATL-APK80-000	76.06
10"	ATL-APK100-000	148.09

### Hydraulic Cylinders

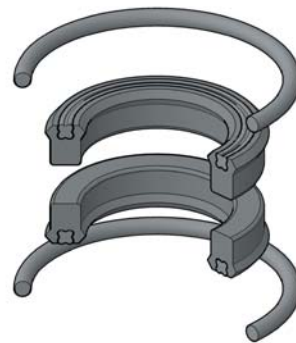

**Kit Includes:**  
 2 URE Loaded U-seals  
 2 NBR O-rings

Kit #	List Price
ATL-HPK15-000	\$ 15.02
ATL-HPK20-000	16.84
ATL-HPK25-000	18.28
ATL-HPK35-000	27.39
ATL-HPK40-000	33.03
ATL-HPK50-000	41.04
ATL-HPK60-000	49.06
ATL-HPK80-000	99.83
—	

ATLAS

# ATLAS

ATLAS

Kit Number	Code	Rod Size	Bore Size	List Price
ATL-1B00S015S	N-N-5		1-1/2	\$ 16.38
ATL-1B00S015V	N-N-5		1-1/2	49.62
ATL-1B00S020S	N-N-5		2	19.08
ATL-1B00S020V	N-N-5		2	55.23
ATL-1B00S025S	N-N-5		2-1/2	20.37
ATL-1B00S025V	N-N-5		2-1/2	58.62
ATL-1B00S032S	N-N-5		3-1/4	31.37
ATL-1B00S032V	N-N-5		3-1/4	83.74
ATL-1B00S040S	N-N-5		4	40.24
ATL-1B00S040V	N-N-5		4	120.68
ATL-1B00S050S	N-N-5		5	84.56
ATL-1B00S050V	N-N-5		5	181.70
ATL-1B00S060S	N-N-5		6	144.89
ATL-1B00S060V	N-N-5		6	246.63
ATL-1B00S070S	N-N-5		7	189.31
ATL-1B00S070V	N-N-5		7	378.76
ATL-1B00S080S	N-N-5		8	200.94
ATL-1B00S080V	N-N-5		8	397.69
ATL-1B00S100S	N-N-5		10	262.68
ATL-1B00S100V	N-N-5		10	527.04
ATL-1B00S120S	N-N-5		12	333.79
ATL-1B00S120V	N-N-5		12	647.21
ATL-1E00S015S	Head Seal Kit		1-1/2	3.99
ATL-1E00S015V	Head Seal Kit		1-1/2	5.93
ATL-1E00S020S	Head Seal Kit		2	5.12
ATL-1E00S020V	Head Seal Kit		2	7.06
ATL-1E00S025S	Head Seal Kit		2-1/2	6.85
ATL-1E00S025V	Head Seal Kit		2-1/2	8.47
ATL-1E00S032S	Head Seal Kit		3-1/4	12.80
ATL-1E00S032V	Head Seal Kit		3-1/4	16.74
ATL-1E00S040S	Head Seal Kit		4	15.48
ATL-1E00S040V	Head Seal Kit		4	18.11
ATL-1E00S050S	Head Seal Kit		5	18.56
ATL-1E00S050V	Head Seal Kit		5	28.17
ATL-1E00S060S	Head Seal Kit		6	29.13
ATL-1E00S060V	Head Seal Kit		6	30.42
ATL-1E00S070S	Head Seal Kit		7	61.70
ATL-1E00S070V	Head Seal Kit		7	71.73
ATL-1E00S080S	Head Seal Kit		8	65.62
ATL-1E00S080V	Head Seal Kit		8	83.71
ATL-1E00S100S	Head Seal Kit		10	119.32
ATL-1E00S100V	Head Seal Kit		10	134.39
ATL-1E00S120S	Head Seal Kit		12	135.61
ATL-1E00S120V	Head Seal Kit		12	154.71
ATL-4A06R000S	I-U-1	5/8		85.70
ATL-4A06R000V	I-U-1	5/8		113.80
ATL-4A06S000S	I-U-1	5/8		9.77
ATL-4A06S000V	I-U-1	5/8		27.13
ATL-4A07S000S	I-U-1	3/4		13.16
ATL-4A07S000V	I-U-1	3/4		38.93

Kit Number	Code	Rod Size	Bore Size	List Price
ATL-4A10R000S	I-U-1	1		\$ 100.85
ATL-4A10R000V	I-U-1	1		133.73
ATL-4A10S000S	I-U-1	1		9.78
ATL-4A10S000V	I-U-1	1		27.97
ATL-4A13R000S	I-U-1	1-3/8		120.80
ATL-4A13R000V	I-U-1	1-3/8		138.02
ATL-4A13S000S	I-U-1	1-3/8		10.03
ATL-4A13S000V	I-U-1	1-3/8		29.42
ATL-4A17R000S	I-U-1	1-3/4		142.42
ATL-4A17R000V	I-U-1	1-3/4		164.15
ATL-4A17S000S	I-U-1	1-3/4		12.63
ATL-4A17S000V	I-U-1	1-3/4		32.98
ATL-4A20R000S	I-U-1	2		167.08
ATL-4A20R000V	I-U-1	2		192.12
ATL-4A20S000S	I-U-1	2		14.11
ATL-4A20S000V	I-U-1	2		34.34
ATL-4A25R000S	I-U-1	2-1/2		190.05
ATL-4A25R000V	I-U-1	2-1/2		228.62
ATL-4A25S000S	I-U-1	2-1/2		19.21
ATL-4A25S000V	I-U-1	2-1/2		43.42
ATL-4A30R000S	I-U-1	3		234.73
ATL-4A30R000V	I-U-1	3		276.80
ATL-4A30S000S	I-U-1	3		27.43
ATL-4A30S000V	I-U-1	3		50.99
ATL-4A35S000S	I-U-1	3-1/2		30.01
ATL-4A35S000V	I-U-1	3-1/2		63.40
ATL-4A40S000S	I-U-1	4		32.21
ATL-4A40S000V	I-U-1	4		97.03
ATL-4A45S000S	I-U-1	4-1/2		39.34
ATL-4A45S000V	I-U-1	4-1/2		109.42
ATL-4A50S000S	I-U-1	5		45.86
ATL-4A50S000V	I-U-1	5		147.17
ATL-4B00S015S	N-N-5		1-1/2	7.87
ATL-4B00S015V	N-N-5		1-1/2	36.15
ATL-4B00S020S	N-N-5		2	9.38
ATL-4B00S020V	N-N-5		2	41.33
ATL-4B00S025S	N-N-5		2-1/2	10.74
ATL-4B00S025V	N-N-5		2-1/2	57.27
ATL-4B00S032S	N-N-5		3-1/4	13.04
ATL-4B00S032V	N-N-5		3-1/4	61.49
ATL-4B00S040S	N-N-5		4	16.62
ATL-4B00S040V	N-N-5		4	72.92
ATL-4B00S050S	N-N-5		5	20.12
ATL-4B00S050V	N-N-5		5	90.44
ATL-4B00S060S	N-N-5		6	26.14
ATL-4B00S060V	N-N-5		6	124.38
ATL-4B00S070S	N-N-5		7	72.88
ATL-4B00S070V	N-N-5		7	224.89
ATL-4B00S080S	N-N-5		8	82.68
ATL-4B00S080V	N-N-5		8	271.13

# ATLAS

Kit Number	Code	Rod Size	Bore Size	List Price	Kit Number	Code	Rod Size	Bore Size	List Price
ATL-4B00S100S	N-N-5		10	\$ 117.69	ATL-EA20S000S	I-U-1	2		\$ 14.25
ATL-4B00S100V	N-N-5		10	375.74	ATL-EA25R000S	I-U-1	2-1/2		186.84
ATL-4B00S120S	N-N-5		12	159.28	ATL-EA25S000S	I-U-1	2-1/2		16.29
ATL-4B00S120V	N-N-5		12	583.20	ATL-EA30R000S	I-U-1	3		248.82
ATL-4B00S140S	N-N-5		14	246.61	ATL-EA30S000S	I-U-1	3		33.02
ATL-4B00S140V	N-N-5		14	859.73	ATL-EA35S000S	I-U-1	3-1/2		47.81
ATL-4E00S015S	Head Seal Kit		1-1/2	4.56	ATL-EA40S000S	I-U-1	4		53.28
ATL-4E00S015V	Head Seal Kit		1-1/2	6.56	ATL-EA45S000S	I-U-1	4-1/2		59.25
ATL-4E00S020S	Head Seal Kit		2	4.84	ATL-EA50S000S	I-U-1	5		64.27
ATL-4E00S020V	Head Seal Kit		2	11.15	ATL-EB00S015S	N-N-5		1-1/2	7.87
ATL-4E00S025S	Head Seal Kit		2-1/2	5.41	ATL-EB00S020S	N-N-5		2	9.38
ATL-4E00S025V	Head Seal Kit		2-1/2	14.61	ATL-EB00S025S	N-N-5		2-1/2	10.74
ATL-4E00S032S	Head Seal Kit		3-1/4	5.48	ATL-EB00S032S	N-N-5		3-1/4	13.04
ATL-4E00S032V	Head Seal Kit		3-1/4	17.06	ATL-EB00S040S	N-N-5		4	16.62
ATL-4E00S040S	Head Seal Kit		4	5.75	ATL-EB00S050S	N-N-5		5	20.12
ATL-4E00S040V	Head Seal Kit		4	21.97	ATL-EB00S060S	N-N-5		6	26.14
ATL-4E00S050S	Head Seal Kit		5	6.72	ATL-4B00S070S	N-N-5		7	72.88
ATL-4E00S050V	Head Seal Kit		5	30.92	ATL-EB00S080S	N-N-5		8	82.68
ATL-4E00S060S	Head Seal Kit		6	8.32	ATL-HPK15-000	N-N-5		1-1/2	15.02
ATL-4E00S060V	Head Seal Kit		6	32.62	ATL-HPK20-000	N-N-5		2	16.84
ATL-4E00S070S	Head Seal Kit		7	8.43	ATL-HPK25-000	N-N-5		2-1/2	18.28
ATL-4E00S070V	Head Seal Kit		7	46.10	ATL-HPK35-000	N-N-5		3-1/4	27.39
ATL-4E00S080S	Head Seal Kit		8	10.27	ATL-HPK40-000	N-N-5		4	33.03
ATL-4E00S080V	Head Seal Kit		8	46.24	ATL-HPK50-000	N-N-5		5	41.04
ATL-4E00S100S	Head Seal Kit		10	11.91	ATL-HPK60-000	N-N-5		6	49.06
ATL-4E00S100V	Head Seal Kit		10	51.50	ATL-HPK80-000	N-N-5		8	99.83
ATL-4E00S120S	Head Seal Kit		12	13.74	ATL-HRK100	I-U-1	1		10.15
ATL-4E00S120V	Head Seal Kit		12	62.10	ATL-HRK137	I-U-1	1-3/8		11.78
ATL-4E00S140S	Head Seal Kit		14	69.52	ATL-HRK175	I-U-1	1-3/4		13.01
ATL-4E00S140V	Head Seal Kit		14	124.67	ATL-HRK200	I-U-1	2		13.95
ATL-90030340-69	I-U-1	1-3/4		12.29	ATL-HRK62	I-U-1	5/8		8.47
ATL-90030340-79	I-U-1	1-3/8		13.74	ATL-PH00KH070	N-N-1		7	306.07
ATL-90030370-69	I-U-1	1-3/4		12.18	ATL-PH00KH080	N-N-1		8	372.01
ATL-90030370-79	I-U-1	1-3/8		11.27	ATL-PH00LH015	N-N-5		1-1/2	12.64
ATL-APK100-000	N-N-5		10	148.09	ATL-PH00LH020	N-N-5		2	13.36
ATL-APK20-000	N-N-5		2	12.82	ATL-PH00LH025	N-N-5		2-1/2	15.88
ATL-APK25-000	N-N-5		2-1/2	13.55	ATL-PH00LH032	N-N-5		3-1/4	29.05
ATL-APK40-000	N-N-5		4	37.28	ATL-PH00LH040	N-N-5		4	34.56
ATL-APK50-000	N-N-5		5	37.58	ATL-PH00LH050	N-N-5		5	50.78
ATL-APK60-000	N-N-5		6	44.30	ATL-PH00LH060	N-N-5		6	75.99
ATL-APK80-000	N-N-5		8	76.06	ATL-PH06SH000	I-U-1	5/8		8.84
ATL-EA06R000S	I-U-1	5/8		89.27	ATL-PH10SH000	I-U-1	1		9.55
ATL-EA06S000S	I-U-1	5/8		8.23	ATL-PH13SH000	I-U-1	1-3/8		12.83
ATL-EA10R000S	I-U-1	1		99.84	ATL-PH17SH000	I-U-1	1-3/4		12.95
ATL-EA10S000S	I-U-1	1		8.86	ATL-PH20SH000	I-U-1	2		17.71
ATL-EA13R000S	I-U-1	1-3/8		114.75	ATL-PH25SH000	I-U-1	2-1/2		22.09
ATL-EA13S000S	I-U-1	1-3/8		9.45	ATL-PH30SH000	I-U-1	3		23.44
ATL-EA17R000S	I-U-1	1-3/4		135.50	ATL-PH35SH000	I-U-1	3-1/2		45.35
ATL-EA17S000S	I-U-1	1-3/4		11.05	ATL-PK1502MA01	N-N-5		1-1/2	23.67
ATL-EA20R000S	I-U-1	2		166.26	ATL-PK1502MA05	N-N-5		1-1/2	46.12



# ATLAS

ATLAS

Kit Number	Code	Rod Size	Bore Size	List Price	Kit Number	Code	Rod Size	Bore Size	List Price
ATL-PK2002MA01	N-N-5		2	\$ 23.99	ATL-RG02MA-06	Bronze Rod Gland	5/8		\$ 26.11
ATL-PK2002MA05	N-N-5		2	49.38	ATL-RG02MA-10	Bronze Rod Gland	1		32.68
ATL-PK2502MA01	N-N-5		2-1/2	25.72	ATL-RG02MA-13	Bronze Rod Gland	1-3/8		47.25
ATL-PK2502MA05	N-N-5		2-1/2	65.55	ATL-RG02MA-17	Bronze Rod Gland	1-3/4		77.01
ATL-PK3202MA01	N-N-5		3-1/4	30.92	ATL-RK02MA0051	I-N-1	1/2		12.70
ATL-PK3202MA05	N-N-5		3-1/4	81.02	ATL-RK02MA0055	I-N-1	1/2		18.98
ATL-PK4002MA01	N-N-5		4	37.91	ATL-RK02MA0061	I-N-1	5/8		13.09
ATL-PK4002MA05	N-N-5		4	91.79	ATL-RK02MA0065	I-N-1	5/8		19.50
ATL-PK5002MA01	N-N-5		5	49.06	ATL-RK02MA0101	I-N-1	1		13.42
ATL-PK5002MA05	N-N-5		5	138.91	ATL-RK02MA0105	I-N-1	1		20.14
ATL-PK6002MA01	N-N-5		6	65.59	ATL-RK02MA0131	I-N-1	1-3/8		14.36
ATL-PK6002MA05	N-N-5		6	196.74	ATL-RK02MA0135	I-N-1	1-3/8		25.22
ATL-PK8002MA01	N-N-5		8	115.80	ATL-RK02MA0171	I-N-1	1-3/4		15.34
ATL-PK8002MA05	N-N-5		8	328.99	ATL-RK02MA0175	I-N-1	1-3/4		31.71
ATL-RGAL-06	Bronze Rod Gland	5/8		76.60	ATL-VH00KH070	N-N-1		7	309.60
ATL-RGAL-10	Bronze Rod Gland	1		86.03	ATL-VH00KH080	N-N-1		8	382.00
ATL-RGAL-13	Bronze Rod Gland	1-3/8		100.85	ATL-VH00LH015	N-N-5		1-1/2	44.46
ATL-RGAL-17	Bronze Rod Gland	1-3/4		117.76	ATL-VH00LH020	N-N-5		2	64.06
ATL-RGAL-20	Bronze Rod Gland	2		142.85	ATL-VH00LH025	N-N-5		2-1/2	73.77
ATL-RGAL-25	Bronze Rod Gland	2-1/2		161.29	ATL-VH00LH032	N-N-5		3-1/4	85.21
ATL-RGAL-30	Bronze Rod Gland	3		200.72	ATL-VH00LH040	N-N-5		4	194.85
ATL-RG02MA0051	I-N-1	1/2		39.34	ATL-VH00LH050	N-N-5		5	292.73
ATL-RG02MA0055	I-N-1	1/2		41.92	ATL-VH00LH060	N-N-5		6	344.18
ATL-RG02MA0061	I-N-1	5/8		25.99	ATL-VH06SH000	I-U-1	5/8		27.00
ATL-RG02MA0065	I-N-1	5/8		41.51	ATL-VH10SH000	I-U-1	1		38.11
ATL-RG02MA0101	I-N-1	1		29.78	ATL-VH13SH000	I-U-1	1-3/8		39.75
ATL-RG02MA0105	I-N-1	1		45.99	ATL-VH17SH000	I-U-1	1-3/4		47.13
ATL-RG02MA0131	I-N-1	1-3/8		44.47	ATL-VH20SH000	I-U-1	2		53.97
ATL-RG02MA0135	I-N-1	1-3/8		66.48	ATL-VH25SH000	I-U-1	2-1/2		87.24
ATL-RG02MA0171	I-N-1	1-3/4		90.50	ATL-VH30SH000	I-U-1	3		100.52
ATL-RG02MA0175	I-N-1	1-3/4		101.52	ATL-VH35SH000	I-U-1	3-1/2		139.74
ATL-RG02MA-05	Bronze Rod Gland	1/2		35.43					